

XR® 600E

POWERED MIXER

OPERATING GUIDE





Intended to alert the user to the presence of uninsulated "dangerous voltage" within the product's enclosure that may be of sufficient magnitude to constitute a risk of electric shock to persons.



Intended to alert the user of the presence of important operating and maintenance (servicing) instructions in the literature accompanying the product.

CAUTION: Risk of electrical shock – DO NOT OPEN!

CAUTION: To reduce the risk of electric shock, do not remove cover. No user serviceable parts inside. Refer servicing to qualified service personnel.

WARNING: To prevent electrical shock or fire hazard, do not expose this appliance to rain or moisture. Before using this appliance, read the operating guide for further warnings.

Thank you for purchasing the Peavey XR™ 600E mixer with built-in reverb and power amplifier. This is a six-channel, powerful, easy-to-use, portable mixing console.

Your XR™ 600E features a rugged, heavy-gauge, cold-rolled steel and aluminum chassis, finished in oven-cured epoxy for toughness and screen-printed utilizing the latest photographic film and U.V.-cured ink technology for razor-sharp, hard-wearing control I.D. and calibration graphics.

Every on-board component has been carefully chosen to deliver the highest possible performance. Precision, professional reliability and absolute minimal operating noise characteristics are only among the initial criteria used during the process of selecting the components that ensure that your XR™ 600E becomes an indispensable addition to your live performance equipment.

All printed circuit boards are constructed from rugged, U.S. military-spec material, using the latest automated assembly technology, wave solder, and computer-controlled "all-faults-analyzed-and-corrected" Q.A. procedures.

Each channel features front panel output and monitor level controls, as well as high, mid, low equalization and effects emphasis controls. Every input channel has a studio-quality low impedance (XLR-type input) microphone input as well as a 1/4" line input. Switchable +48 V phantom power is provided.

The unit features dual 150 watt power amplifiers.

6

8

0 5 10
EFX.

7

-15 0 15+
HIGH

6

-15 0 15+
MID

5

-15 0 15+
LOW

4

0 5 10
MON.

3

0 5 10
LEVEL

8

XR[®] 600E

POWERED MIXER

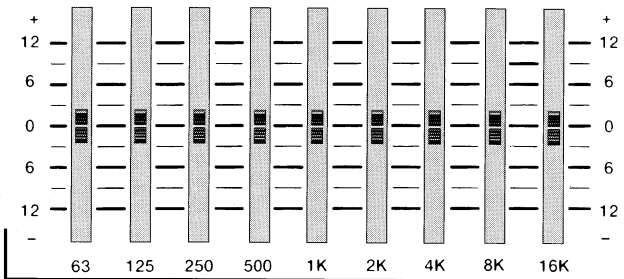

9

0 5 10
MAIN

10

0 5 10
MON.

11

0 5 10
EFX.

12

0 5 10
TAPE

24

0 5 10
EFX. RETURN

13

0 5 10
EFX. RETURN TO MON.

14

0 5 10
TAPE/AUX IN

25

0 5 10
TAPE/AUX TO MON.

26

TAPE OUT

27 28

TAPE IN

29
POWER

2

LINE

1

MIC

15

ON
OFF
PHANTOM POWER

OUTPUTS

GRAPHIC EQ

16
MAIN

17
MON.

18
EFX.

19
GR. IN

20
GR. OUT

21
EFX. FS

22
AUX IN

23
PA 1 IN
PA 2 IN

BALANCED LOW IMPEDANCE INPUT (1)

For use with low impedance microphones or low-level sources equipped with an XLR connector.

LINE INPUT JACK(2)

For use with line level signal or compatible high Z microphones equipped with a 1/4" phone plug.

NOTE: It is possible to use both the mic and line inputs on a single channel simultaneously. It is, however, unlikely that the gain matching of the mic and line will allow this hookup to be useful. This practice is not recommended.

LEVEL (3)

Controls the channel output level. Maximum output level is obtained by rotating this control fully clockwise. Minimum output level is obtained by rotating this control fully counterclockwise.

MONITOR (4)

Controls the channel monitor mix level. This is independent of all other channel controls. Maximum channel monitor mix level is obtained by rotating this control fully clockwise. Minimum channel monitor mix level is obtained by rotating this control fully counterclockwise.

LOW EQ (5)

Controls the channel low EQ level. An active tone control (shelving type, ± 15 dB) that varies the low frequency range. Maximum low EQ boost is obtained by rotating this control fully clockwise. Maximum low EQ cut is obtained by rotating this control fully counterclockwise.

MID EQ (6)

Controls the channel mid EQ level. An active tone control (peak/notch, ± 12 dB) that adjusts the mid frequency range. Maximum mid EQ boost is obtained by rotating this control fully clockwise. Maximum mid EQ cut is obtained by rotating this control fully counterclockwise.

HIGH EQ CONTROL (7)

Controls the channel high EQ level. An active tone control (shelving type, ± 15 dB) that varies the high frequency range. Maximum high EQ boost is obtained by rotating this control fully clockwise. Maximum high EQ cut is obtained by rotating this control fully counterclockwise.

EFFECTS SEND (8)

Controls the channel effects drive level. Maximum effects signal is obtained by rotating the control fully clockwise. Minimum signal level cut is obtained by rotating this control fully counterclockwise.

MASTER SECTION:

9-BAND GRAPHIC EQ (9)

Provides ± 12 dB equalization at each center frequency. EQ boost is obtained by moving a particular EQ band's slide control above the center line. EQ cut is obtained by moving a particular EQ band's slide control below the center line.

OPERATION NOTE: This equalizer is designed to provide room equalization, feedback control and system tone control. No amount of equalization will correct the response curve of a poor loudspeaker. Always begin with all sliders in the "0" position and avoid excessively cutting large segments of the audio passband, which would limit the system's dynamic range.

MASTER GAIN (10)

Controls the overall volume level of the main system. The signal from this control is available at the main output (16). Under normal conditions this signal is also internally patched through the graphic EQ and power amplifier so that this control sets the volume of the speakers connected to the external speaker jacks (33). Maximum master signal level is obtained by rotating this control fully clockwise. Minimum master signal level cut is obtained by rotating this control fully counterclockwise.

MASTER MONITOR (11)

Controls the overall monitor mix level. Maximum monitor signal level is obtained by rotating this control fully clockwise. Minimum monitor signal level is obtained by rotating this control fully counterclockwise.

EFFECTS MASTER (12)

Controls the effects level supplied to the internal reverb and the effects out jack. Maximum effects signal level is obtained by rotating this control fully clockwise. Minimum effects signal level is obtained by rotating this control fully counterclockwise.

REVERB RETURN (13)

Controls the level of the internal reverb EFX in the main system mix. Maximum effects return signal level is obtained by rotating the control fully clockwise. Minimum effects return signal level is obtained by rotating this control fully counterclockwise.

REVERB TO MONITOR (14)

Controls the level of the internal reverb EFX in the monitor system. Maximum monitor effects signal level is obtained by rotating this control fully clockwise. Minimum monitor effects signal level is obtained by rotating this control fully counterclockwise.

PHANTOM POWER ON/OFF (15)

This switch selects phantom power "ON" or "OFF" for all channels. Phantom power is on when the switch is in the down position and off when the switch is in the up position.

MASTER OUTPUT/INPUT SECTION**MAIN OUTPUT (16)**

This 1/4" jack provides a signal from the main system mix before the graphic equalizer. Used primarily to feed an auxiliary amplifier/speaker system. (See wiring diagram).

MONITOR OUTPUT (17)

This 1/4" jack provides a signal from the MONITOR mix for an external monitor amplifier/speaker system. The level is determined by the channel monitor and master monitor controls.

EFX OUTPUT (18)

This 1/4" jack provides a signal from the EFX mix for external effects or signal-processing equipment.

GRAPHIC INPUT (19)

This 1/4" jack provides an input to the internal graphic equalizer/power amp. This is a switching jack: a signal inserted here interrupts the normal signal path from the main bus into the equalizer.

OPERATION NOTE: This jack permits the equalizer to be switched away from its normal input and accept an external signal to be equalized.

GRAPHIC OUT (20)

This 1/4" jack provides access to the output of the internal graphic equalizer.

FOOTSWITCH (21)

This 1/4" jack provides access for connection of a footswitch (optional) and is used to activate/defeat the internal reverb.

AUXILIARY INPUT (22)

This 1/4" jack provides access to an input to the main mixing bus for patching in returns from external effects devices, extra mixing channels, etc. Using this jack defeats both tape-in jacks.

POWER AMP INPUTS (23)

These 1/4" jacks provide access to connect external line-level signals to the power amplifiers.

OPERATION NOTE: These jacks permit the two internal power amplifiers to be switched away from their normal inputs and to accept external line-level signals.

TAPE SECTION:**TAPE OUT LEVEL (24)**

Controls the signal level at the tape-out jacks (28). Operation is independent of the main master level control (10) and the graphic equalizer (9).

TAPE/AUX IN LEVEL (25)

When external signals are patched into the tape-in jacks (27) or the auxiliary input (22), TAPE/AUX IN LEVEL (25) provides control over the level of signals sent from these inputs to the main mix. Using the auxiliary input jack defeats the tape-in jacks. Maximum TAPE/AUX to main mix signal level is obtained by rotating this control fully clockwise. Minimum TAPE/AUX to main mix signal level is obtained by rotating this control fully counterclockwise.

TAPE AUX TO MON (26)

Allows the TAPE/AUX to be assigned to the monitor.

TAPE OUT/TAPE IN: CAUTION

Before placing connected tape decks in the "record" mode, set the TAPE/AUX IN level control to "0" or off. Most tape decks feed the input signal directly to the output when in record mode. This creates a "closed loop" condition from the tape-out to tape-in jack which can affect the operational level or sonic quality of the system.

TAPE IN JACKS (27)

These two jacks provide a paralleled input for proper mono mixing of stereo tape deck outputs. For monaural tape sources, use either jack. These inputs are defeated when the AUX INPUT (22) is used.

TAPE OUT JACKS (28)

These two jacks provide the same monaural signal to be supplied to the left and right inputs of a stereo tape deck. Output level is determined by the TAPE OUT (24) level control.

POWER INDICATOR:**PILOT LIGHT LED (29)**

Illuminates when AC power is being supplied to the amp.

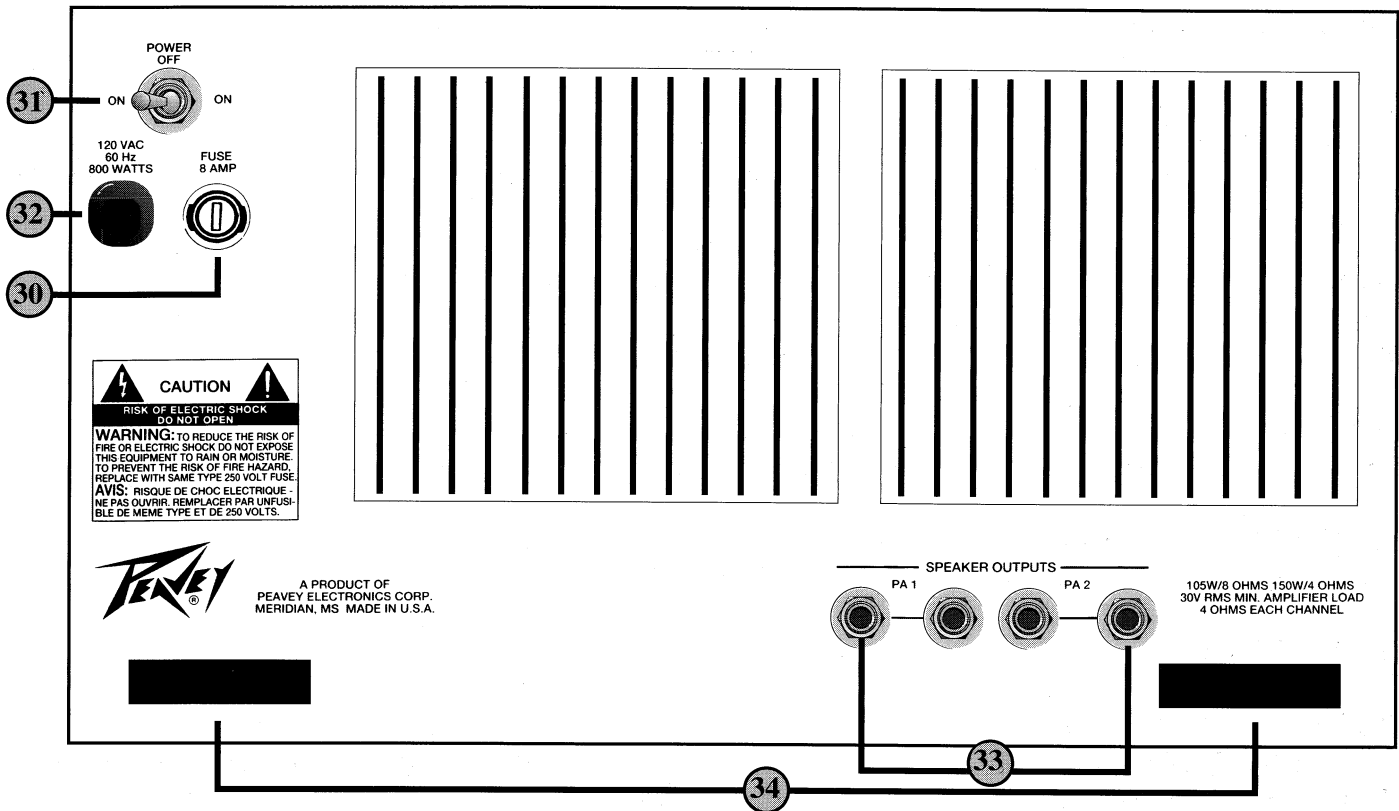

AC POWER AND POWER AMPLIFIER OUTPUT SECTION:

FUSE (30)

The fuse is located within the cap of the fuseholder. If the fuse should fail, IT MUST BE REPLACED WITH THE SAME TYPE AND VALUE IN ORDER TO AVOID DAMAGE TO THE EQUIPMENT AND TO PREVENT VOIDING THE WARRANTY. If the amp repeatedly blows fuses, it should be taken to a qualified service center for repair.

WARNING: THE FUSE SHOULD ONLY BE REPLACED WHEN THE POWER CORD HAS BEEN DISCONNECTED FROM ITS POWER SOURCE.

POWER SWITCH (31)

Center position is OFF. Two ON positions are provided, one of which will properly ground the amplifier. Switch to the ON side that yields the lowest amount of residual hum or popping noise when the instrument is touched. 220 and 240 volt models have a two-way on/off switch only.

LINE CORD (120 V PRODUCTS ONLY) (32)

For your safety, we have incorporated a 3-wire line (mains) cable with proper grounding facilities. It is not advisable to remove the ground pin under any circumstances. If it is necessary to use the equipment without proper grounding facilities, suitable grounding adaptors should be used. Less noise and greatly reduced shock hazard exist when the unit is operated with the proper grounded receptacles.

EXTERNAL SPEAKER JACKS (33)

Provided for connection of external speaker cabinet. Minimum total impedance is 4 ohms for each amplifier.

LINE (MAINS) CORD RETAINERS (34)

Allow storage of mains cable for travel.

NOTE: The line cord should be removed from the cord retainers before use.

SPECIFICATIONS

NOTE: All specifications are typical unless otherwise noted.

0 dBV = 1 volt RMS
0 dBu = .778 volts RMS

All specs are referenced to nominal output level (0 dBV) unless otherwise noted.

All measurements are wideband 20 Hz to 20 kHz unless otherwise stated.

All control settings are nominal (50% rotation) unless otherwise noted.

CHANNEL

Equivalent Input Noise:

-114.5 dBV @ 40 dB max gain

Frequency Response:

(to speaker outputs)
 ± 1 dB 10 Hz to 23,000 Hz

Distortion:

(1 kHz)
Less than .015%

Input Impedance:

Low Z Bal = 1.7 kilohms
Line Input = 13 kilohms

High EQ:

± 15 dB @ 10 kHz minimum
center detent flat ± 2 dB

Mid EQ:

± 12 dB @ 600 Hz minimum
center detent flat ± 2 dB

Low EQ:

± 15 dB @ 50 Hz minimum
Center detent flat ± 2 dB

Nominal Channel Gain:

Low Z = 20 dB
Line = 0 dB

Minimum Channel Gain:

Low Z = -69 dB
Line = -89 dB

Maximum Channel Gain:

Low Z = 40 dB
Line = 20 dB

Nominal Input Level:

Low Z = -20dBV
Line = 0dBV

Minimum Input Level:

Low Z = -40dBV
Line = -20dBV

Maximum Input Level:

Low Z = +6dB
Line = +26dB

Phantom Power:

+48 V DC

GRAPHIC EQUALIZER:

Filter Bandwidth:

1 octave

Filter Frequencies:

(ISO Stds.)
63 Hz, 125 Hz, 250 Hz, 1 kHz, 2 kHz, 4 kHz, 8 kHz, 16 kHz

Filter Q:

1.57

Maximum Boost & Cut:

± 12 dB

Noise:

-102 dBV

Distortion:

(1 kHz)
Less than .005%

Frequency Response:

± 1 dB, 7 Hz to 40 kHz

Input Level:

Nom = 0 dBV (1.0 V RMS)
Max = +19 dBV (9 V RMS)

Output Level:

Nom = 0 dBV (1.0 V RMS)
Max = +19 dBV (9 V RMS)

Input Impedance:

10 kilohms

Output Impedance:

100 ohms

MASTER**Gain:**

Main: = 20 dB
 Monitor: = 15 dB
 Tape: = 15 dB
 Effects: = 15 dB

Maximum Output Level:

Main: = +18 dBV (8.0 V RMS)
 Monitor: = +18 dBV (8.0 V RMS)
 Tape: = +18 dBV (8.0 V RMS)
 Effects: = +18 dBV (8.0 V RMS)

Nominal Headroom:

Main: = 18 dB
 Monitor: = 18 dB
 Tape: = 18 dB
 Effects: = 18 dB

Output Impedance:

Main: = 100 ohms
 Monitor: = 100 ohms
 Tape: = 10k ohms
 Effects: = 100 ohms

Output Noise:

Residual: -101 dBV
 (Master Level Down)

Bus: -94 dBV
 (Master Nominal, All Channel Level Full CCW,
 Effects Returns Down)

Nominal: -86 dBV
 (All Controls Nominal, Low Z Input Terminated
 150 ohms)

Aux Input Impedance:

120 kilohms

Aux Input Level:

Nom: 0 dBV
 Max: +7 dBV
 Min: -15 dBV

Tape Input Level:

Nom: +4 dBV
 Max: +11 dBV
 Min: -10 dBV

**POWER AMP SECTION
(300 SC Module with DDT™)****Frequency Response:**

+0, -1 dB 10 Hz to 40 kHz @ Rated Power

Rated Power:

150 watts RMS into 4 ohms, both channels driven.
 100 watts RMS into 8 ohms, both channels driven.

Power @ Clipping:

(1% THD, 1 kHz, 120 VAC line, typical)
 160 watts RMS into 4 ohms, each channel, both
 channels driven.
 113 watts RMS into 8 ohms, each channel, both
 channels driven.
 225 watts RMS into 4 ohms, one channel driven.
 130 watts RMS into 8 ohms, one channel driven.

Intermodulation Distortion:

Less than 0.1%, (10 mW to rated power, 250 Hz & 7
 kHz, 4 ohms)

Total Harmonic Distortion:

Less than 0.1%

DDT™ Dynamic Range:

Greater than 26 dB

DDT™ Maximum Distortion:

Below 0.5% THD for 6 dB overload
 Below 1% THD for 20 dB overload

Hum & Noise:

-92 dB below 150 watts

Slew Rate:

15 V/μSec

Damping Factor:

Greater than 100 @ 1 kHz, 4 ohms

Input Sensitivity:

1 V RMS For 150 watts @ 4 ohms

Input Impedance:

19 kilohms

Power Requirements:

800 watts, 120 V AC, 60 Hz

XR® 600E LEVEL CHART

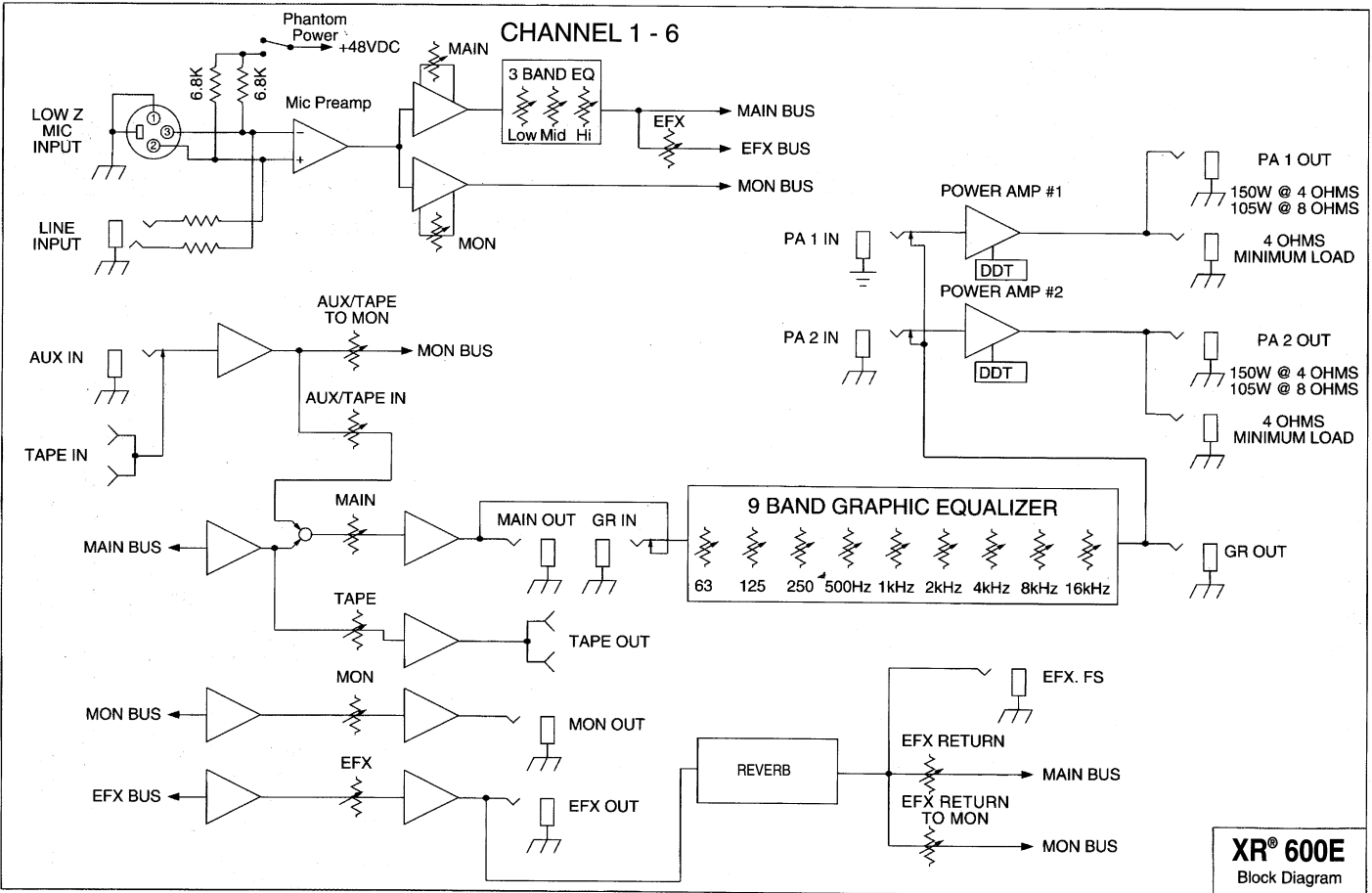
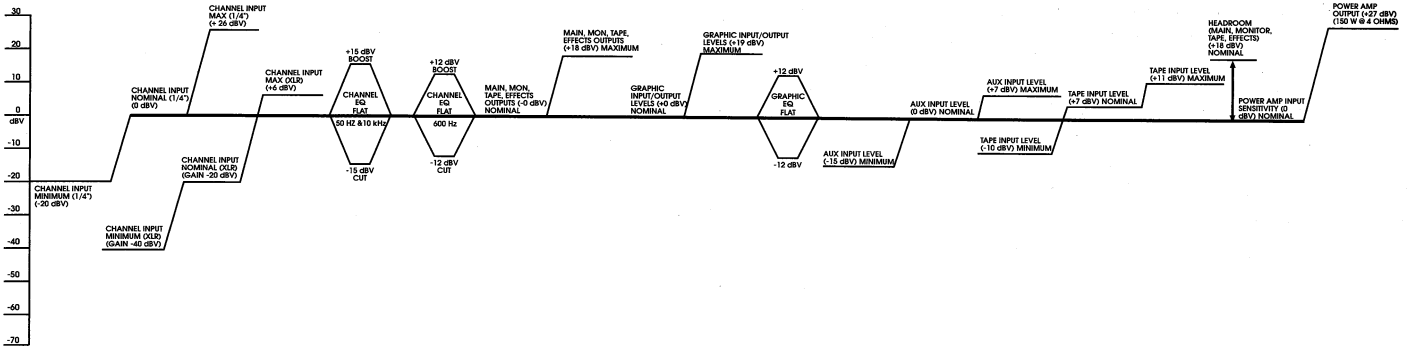

XR® 600E
Block Diagram

XR 600E internal EQ and power amp for mains. External EQ and power amp for monitors.

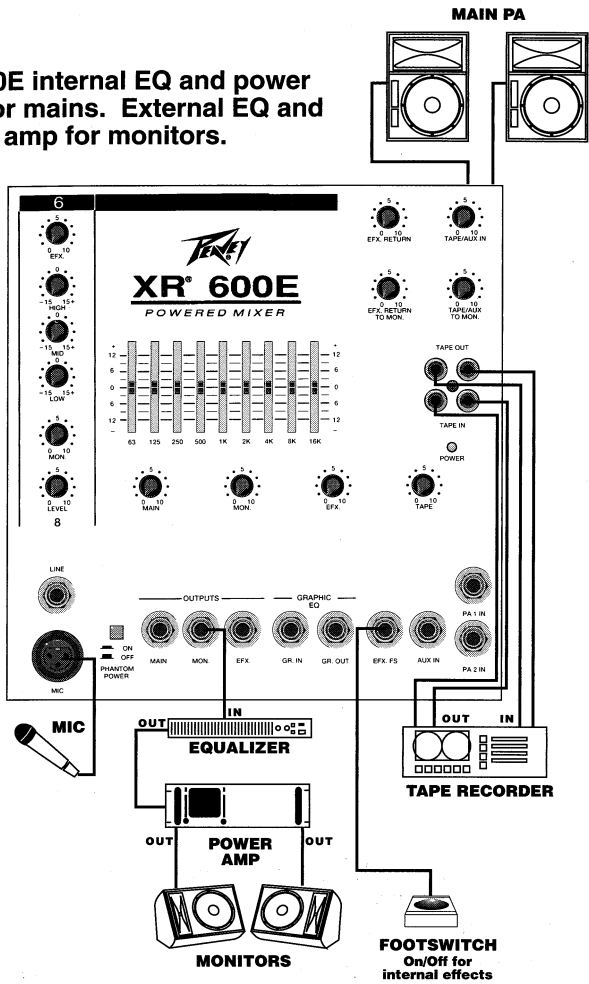

XR 600E internal EQ & external power amp on mains. External EQ & internal power amp for monitors.

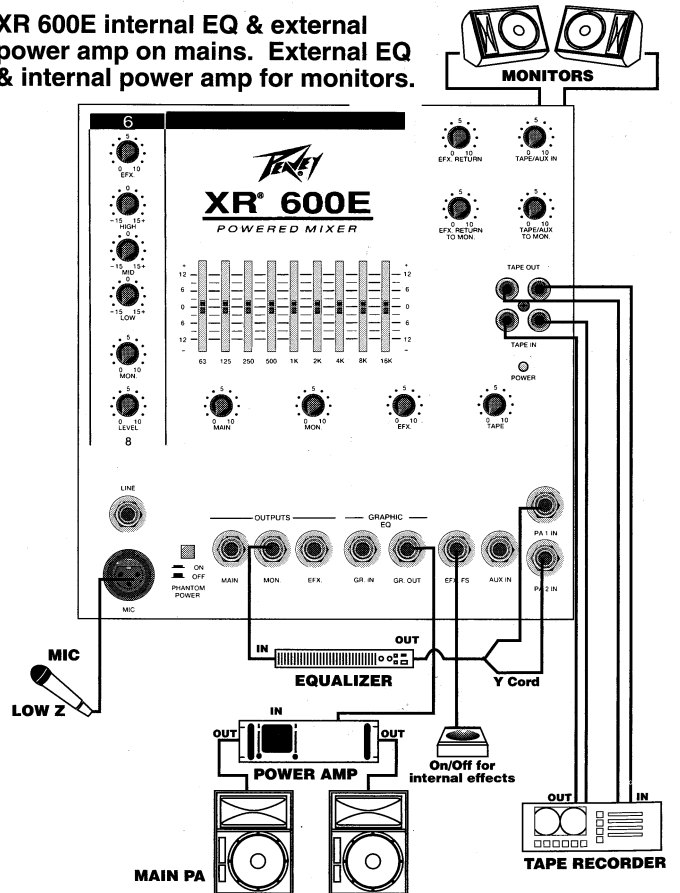

XR 600E external EQ & power amp for mains. Internal EQ & power amp for monitors.

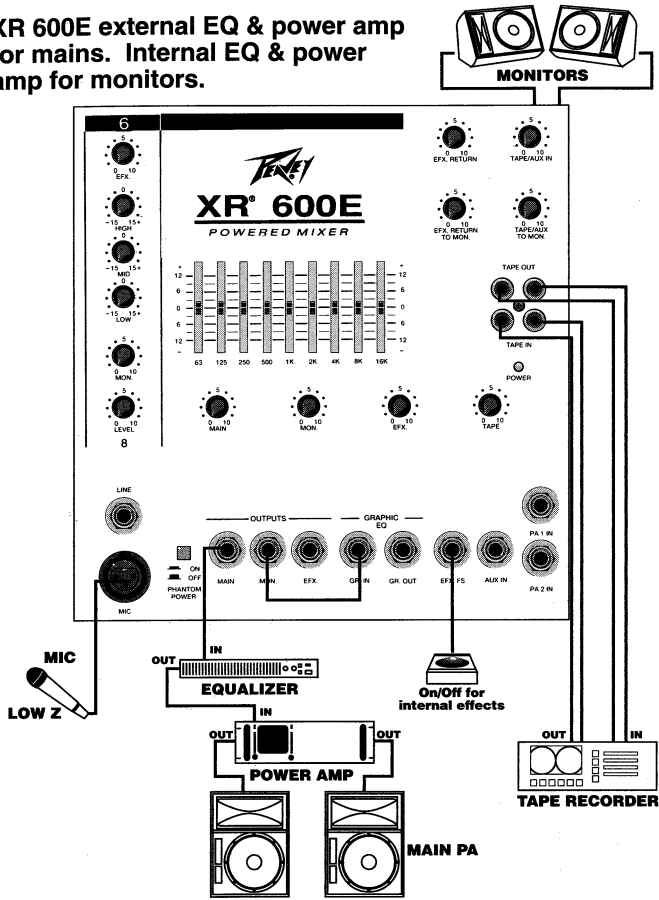

XR 600E internal EQ & power amp for mains. External EQ & internal power amp for monitors.

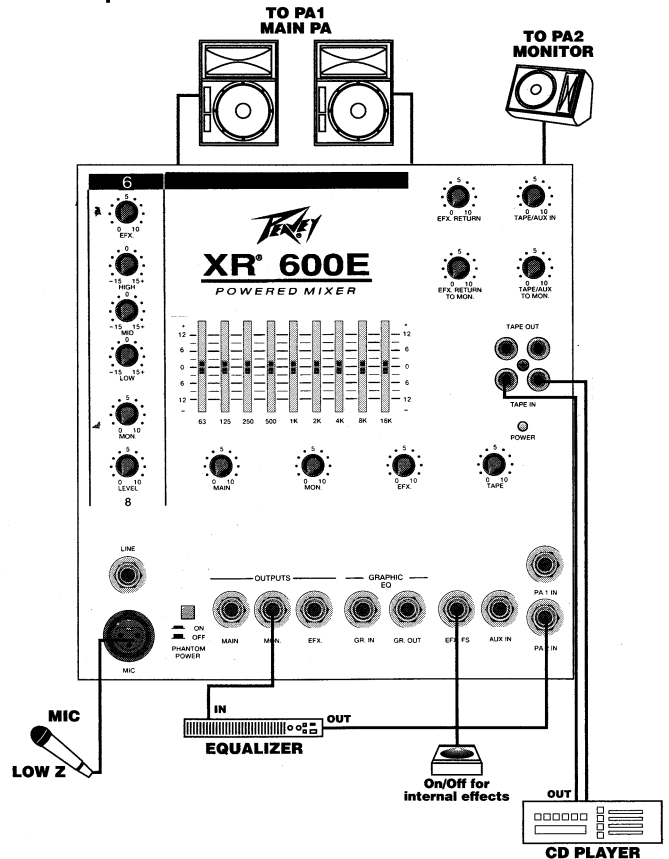

**XR 600E external EQ & internal
power amp for mains. Internal EQ
& internal power amp for monitors.**

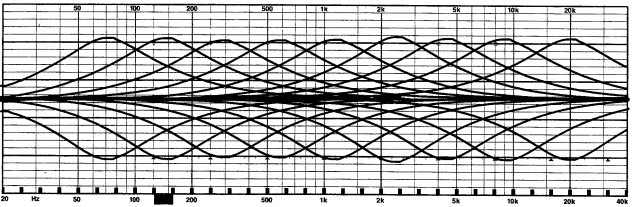
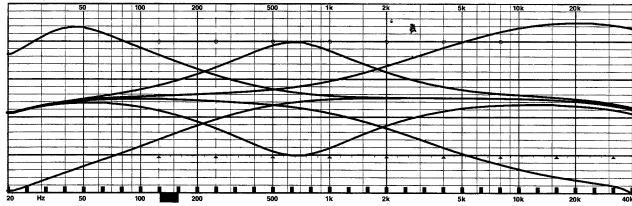
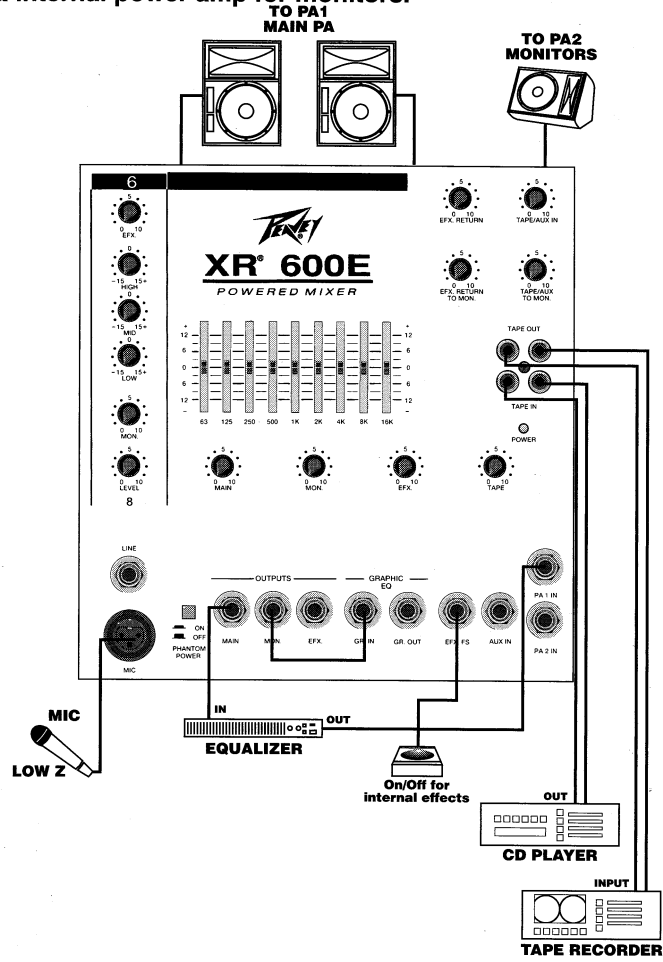

THIS LIMITED WARRANTY VALID ONLY WHEN PURCHASED AND REGISTERED IN THE UNITED STATES OR CANADA. ALL EXPORTED PRODUCTS ARE SUBJECT TO WARRANTY AND SERVICES TO BE SPECIFIED AND PROVIDED BY THE AUTHORIZED DISTRIBUTOR FOR EACH COUNTRY.

Ces clauses de garantie ne sont valables qu'aux Etats-Unis et au Canada. Dans tout les autres pays, les clauses de garantie et de maintenance sont fixees par le distributeur national et assuree par lui selon la legislation en vigueur.

Diese Garantie ist nur in den USA und Kanada gultig. Alle Export-Produkte sind der Garantie und dem Service des Importeurs des jeweiligen Landes unterworfen. Esta garantia es valida solamente cuando el producto es comprado en E.U. continentales o en Canada. Todos los productos que sean comprados en el extranjero, estan sujetos a las garantias y servicio que cada distribuidor autorizado determine y ofrezca en los diferentes paises.

PEAVEY ONE-YEAR LIMITED

WARRANTY/REMEDY

PEAVEY ELECTRONICS CORPORATION ("PEAVEY") warrants this product, EXCEPT for covers, footswitches, patchcords, tubes and meters, to be free from defects in material and workmanship for a period of one (1) year from date of purchase, PROVIDED, however, that this limited warranty is extended only to the original retail purchaser and is subject to the conditions, exclusions, and limitations hereinafter set forth:

PEAVEY 90-DAY LIMITED WARRANTY ON TUBES AND METERS

If this product contains tubes or meters, Peavey warrants the tubes or meters contained in the product to be free from defects in material and workmanship for a period of ninety (90) days from date of purchase; PROVIDED, however, that this limited warranty is extended only to the original retail purchaser and is also subject to the conditions, exclusions, and limitations hereinafter set forth.

CONDITIONS, EXCLUSIONS, AND LIMITATIONS OF LIMITED WARRANTIES

These limited warranties shall be void and of no effect, if:

- a. The first purchase of the product is for the purpose of resale; or
- b. The original retail purchase is not made from an AUTHORIZED PEAVEY DEALER; or
- c. The product has been damaged by accident or unreasonable use, neglect, improper service or maintenance, or other causes not arising out of defects in material or workmanship; or
- d. The serial number affixed to the product is altered, defaced, or removed.

In the event of a defect in material and/or workmanship covered by this limited warranty, Peavey will:

- a. In the case of tubes or meters, replace the defective component without charge.
- b. In other covered cases (i.e., cases involving anything other than covers, footswitches, patchcords, tubes or meters), repair the defect in material or workmanship or replace the product, at Peavey's option; and provided, however, that, in any case, all costs of shipping, if necessary, are paid by you, the purchaser.

THE WARRANTY REGISTRATION CARD SHOULD BE ACCURATELY COMPLETED AND MAILED TO AND RECEIVED BY PEAVEY WITHIN FOURTEEN (14) DAYS FROM THE DATE OF YOUR PURCHASE.

In order to obtain service under these warranties, you must:

- a. Bring the defective item to any PEAVEY AUTHORIZED DEALER or AUTHORIZED PEAVEY SERVICE CENTER and present therewith the ORIGINAL PROOF OF PURCHASE supplied to you by the AUTHORIZED PEAVEY DEALER in connection with your purchase from him of this product. If the DEALER or SERVICE CENTER is unable to provide the necessary warranty service you will be directed to the nearest other PEAVEY AUTHORIZED DEALER or AUTHORIZED PEAVEY SERVICE CENTER which can provide such service.

OR

- b. Ship the defective item, prepaid, to:

PEAVEY ELECTRONICS CORPORATION
International Service Center
326 Hwy. 11 & 80 East
MERIDIAN, MS 39301

including therewith a complete, detailed description of the problem, together with a legible copy of the original PROOF OF PURCHASE and a complete return address. Upon Peavey's receipt of these items:

If the defect is remedial under these limited warranties and the other terms and conditions expressed herein have been complied with, Peavey will provide the necessary warranty service to repair or replace the product and will return it, FREIGHT COLLECT, to you, the purchaser.

Peavey's liability to the purchaser for damages from any cause whatsoever and regardless of the form of action, including negligence, is limited to the actual damages up to the greater of \$500.00 or an amount equal to the purchase price of the product that caused the damage or that is the subject of or is directly related to the cause of action. Such purchase price will be that in effect for the specific product when the cause of action arose. This limitation of liability will not apply to claims for personal injury or damage to real property or tangible personal property allegedly caused by Peavey's negligence. Peavey does not assume liability for personal injury or property damage arising out of or caused by a non-Peavey alteration or attachment, nor does Peavey assume any responsibility for damage to interconnected non-Peavey equipment that may result from the normal functioning and maintenance of the Peavey equipment.

UNDER NO CIRCUMSTANCES WILL PEAVEY BE LIABLE FOR ANY LOST PROFITS, LOST SAVINGS, ANY INCIDENTAL DAMAGES, OR ANY CONSEQUENTIAL DAMAGES ARISING OUT OF THE USE OR INABILITY TO USE THE PRODUCT, EVEN IF PEAVEY HAS BEEN ADVISED OF THE POSSIBILITY OF SUCH DAMAGES.

THESE LIMITED WARRANTIES ARE IN LIEU OF ANY AND ALL WARRANTIES, EXPRESSED OR IMPLIED, INCLUDING, BUT NOT LIMITED TO, THE IMPLIED WARRANTIES OF MERCHANTABILITY AND FITNESS FOR A PARTICULAR USE; PROVIDED, HOWEVER, THAT IF THE OTHER TERMS AND CONDITIONS NECESSARY TO THE EXISTENCE OF THE EXPRESSED, LIMITED WARRANTIES, AS HEREINABOVE STATED, HAVE BEEN COMPLIED WITH, IMPLIED WARRANTIES ARE NOT DISCLAIMED DURING THE APPLICABLE ONE-YEAR OR NINETY-DAY PERIOD FROM DATE OF PURCHASE OF THIS PRODUCT.

SOME STATES DO NOT ALLOW LIMITATION ON HOW LONG AN IMPLIED WARRANTY LASTS, OR THE EXCLUSION OR LIMITATION OF INCIDENTAL OR CONSEQUENTIAL DAMAGES, SO THE ABOVE LIMITATIONS OR EXCLUSIONS MAY NOT APPLY TO YOU. THESE LIMITED WARRANTIES GIVE YOU SPECIFIC LEGAL RIGHTS, AND YOU MAY ALSO HAVE OTHER RIGHTS WHICH MAY VARY FROM STATE TO STATE.

THESE LIMITED WARRANTIES ARE THE ONLY EXPRESSED WARRANTIES ON THIS PRODUCT, AND NO OTHER STATEMENT, REPRESENTATION, WARRANTY, OR AGREEMENT BY ANY PERSON SHALL BE VALID OR BINDING UPON PEAVEY.

In the event of any modification or disclaimer of expressed or implied warranties, or any limitation of remedies, contained herein conflicts with applicable law, then such modification, disclaimer or limitation, as the case may be, shall be deemed to be modified to the extent necessary to comply with such law.

Your remedies for breach of these warranties are limited to those remedies provided herein and Peavey Electronics Corporation gives this limited warranty only with respect to equipment purchased in the United States of America.

INSTRUCTIONS — WARRANTY REGISTRATION CARD

1. Mail the completed WARRANTY REGISTRATION CARD to:

PEAVEY ELECTRONICS CORPORATION
POST OFFICE BOX 2898
MERIDIAN, MISSISSIPPI 39302-2898

- a. Keep the PROOF OF PURCHASE. In the event warranty service is required during the warranty period, you will need this document. There will be no identification card issued by Peavey Electronics Corporation.

2. IMPORTANCE OF WARRANTY REGISTRATION CARDS AND NOTIFICATION OF CHANGES OF ADDRESSES:

- a. Completion and mailing of WARRANTY REGISTRATION CARDS — Should notification become necessary for any condition that may require correction, the REGISTRATION CARD will help ensure that you are contacted and properly notified.
- b. Notice of address changes — If you move from the address shown on the WARRANTY REGISTRATION CARD, you should notify Peavey of the change of address so as to facilitate your receipt of any bulletins or other forms of notification which may become necessary in connection with any condition that may require dissemination of information or correction.

3. You may contact Peavey directly by telephoning (601) 483-5365.

IMPORTANT SAFETY INSTRUCTIONS

WARNING: When using electric products, basic cautions should always be followed, including the following.

1. Read all safety and operating instructions before using this product.
2. All safety and operating instructions should be retained for future reference.
3. Obey all cautions in the operating instructions and on the back of the unit.
4. All operating instructions should be followed.
5. This product should not be used near water, i.e., a bathtub, sink, swimming pool, wet basement, etc.
6. This product should be located so that its position does not interfere with its proper ventilation. It should not be placed flat against a wall or placed in a built-in enclosure that will impede the flow of cooling air.
7. This product should not be placed near a source of heat such as a stove, radiator, or another heat producing amplifier.
8. Connect only to a power supply of the type marked on the unit adjacent to the power supply cord.
9. Never break off the ground pin on the power supply cord. For more information on grounding, write for our free booklet "Shock Hazard and Grounding."
10. Power supply cords should always be handled carefully. Never walk or place equipment on power supply cords. Periodically check cords for cuts or signs of stress, especially at the plug and the point where the cord exits the unit.
11. The power supply cord should be unplugged when the unit is to be unused for long periods of time.
12. If this product is to be mounted in an equipment rack, rear support should be provided.
13. Metal parts can be cleaned with a damp rag. The vinyl covering used on some units can be cleaned with a damp rag or an ammonia-based household cleaner if necessary. Disconnect unit from power supply before cleaning.
14. Care should be taken so that objects do not fall and liquids are not spilled into the unit through the ventilation holes or any other openings.
15. This unit should be checked by a qualified service technician if:
 - a. The power supply cord or plug has been damaged.
 - b. Anything has fallen or been spilled into the unit.
 - c. The unit does not operate correctly.
 - d. The unit has been dropped or the enclosure damaged.
16. The user should not attempt to service this equipment. All service work should be done by a qualified service technician.
17. This product should be used only with a cart or stand that is recommended by Peavey Electronics.
18. Exposure to extremely high noise levels may cause a permanent hearing loss. Individuals vary considerably in susceptibility to noise induced hearing loss, but nearly everyone will lose some hearing if exposed to sufficiently intense noise for a sufficient time. The U.S. Government's Occupational Safety and Health Administration (OSHA) has specified the following permissible noise level exposures.

| Duration Per Day In Hours | Sound Level dBA, Slow Response |
|---------------------------|--------------------------------|
| 8 | 90 |
| 6 | 92 |
| 4 | 95 |
| 3 | 97 |
| 2 | 100 |
| 1 1/2 | 102 |
| 1 | 105 |
| 1/2 | 110 |
| 1/4 or less | 115 |

According to OSHA, any exposure in excess of the above permissible limits could result in some hearing loss.

Ear plugs or protectors in the ear canals or over the ears must be worn when operating this amplification system in order to prevent a permanent hearing loss if exposure is in excess of the limits as set forth above. To ensure against potentially dangerous exposure to high sound pressure levels, it is recommended that all persons exposed to equipment capable of producing high sound pressure levels such as this amplification system be protected by hearing protectors while this unit is in operation.

SAVE THESE INSTRUCTIONS!



Features and specifications subject to change without notice.